

User Manual for F56 Series

0WRX.466.523

Rev.A.1908

1.Product dimension (Images and dimensions are for reference only, please subject to the final product.)

F52/F56A/F56E/F56F

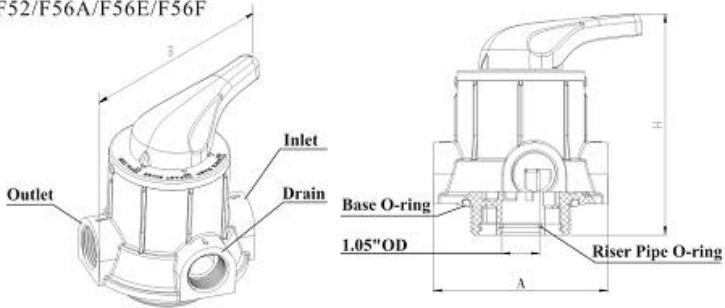

N56D

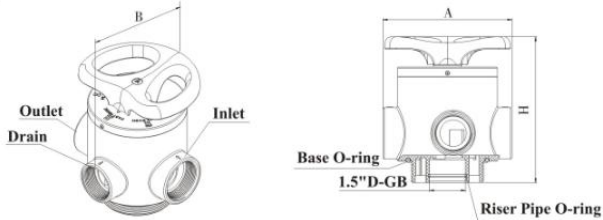

F56AC/F56EC

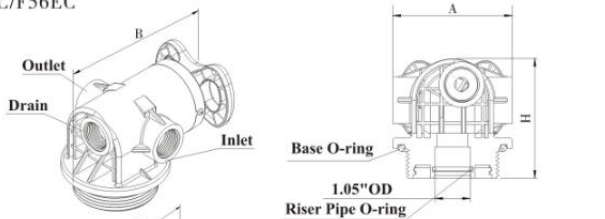

F56L

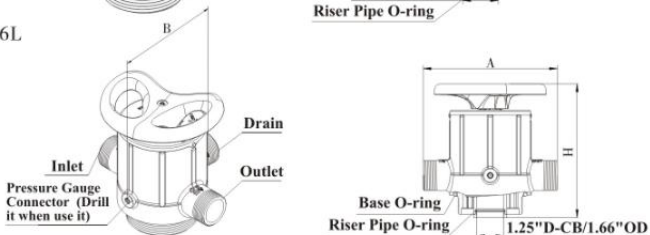

Outer Dimensions

Model	F56A	N56D	F56E	F56F	F56AC	F56EC	F52	F56L
A(mm) max	126	180	92	126	126	92	90	210
B(mm) max	150	178	130	160	175	135	140	193
H(mm) max	158	205	140	165	120	92	135	209

2. Service Conditions

Runxin Valve should be used under the following conditions:

Items		Requirements
Service Conditions	Pressure	0.15MPa~0.6MPa
	Water Temperature	5°C~50°C
Service Environment	Environment Temperature	5°C~50°C
	Relative Humidity	≤95% (25°C)
Source Water Quality	Turbidity	<20FTU

3. Technical Parameters

Old Model	Inlet/ Outlet	Drain	Base	Riser Pipe	Max Flow Rate m ³ /h	Tank Size (inch)	Remark
F52	1/2"F	1/2"F	M82×3	Φ16.5	1	6"~10"	
F56B	1/2" or 3/4"F	1/2" or 3/4"F	Tr95×6 or Φ 98 Sawtooth Thread	1.05"OD	1	10" Filter Shell	
F56C	1/2" or 3/4"F	1/2" or 3/4"F	Tr118×6 or Tr110×6	1.05"OD	1	20" Filter Shell	
F56E	1/2" or 3/4"F	1/2" or 3/4"F	2.5"-8NPSM	1.05"OD	2	6"~10"	

F56EC	1/2" or 3/4"F	1/2" or 3/4"F	2.5"-8NPSM	1.05"OD	2	6"~10"	Side-control
F56A	1"F	1"F	2.5"-8NPSM	1.05"OD	4	6"~12"	
F56AC	1"F	1"F	2.5"-8NPSM	1.05"OD	4	6"~12"	Side-control
F56F	1"F	1"F	2.5"-8NPSM	1"D-GB	6	6"~14"	
N56D	2"F	1.5"F	4"-8UN	1.5"D-GB	10	10"~24"	
F56L	1.5"M	1.5"M	4"-8UN	1.25"D-GB/ 1.66"OD	6	10"~24"	

Note: F = Female Thread M = Male Thread OD = Outer Diameter
D-GB = Chinese Standard Pipe Thread

Water treatment capacity is related to designed flow rate, inlet water pressure and selected filter materials. The above parameters are for reference only.

4. Installation

① The filter should be as much close to the drain outlet as possible; and better make sure to install the system at the place where no much loss would be caused in case of water leakage.

② As in Figure 1, riser pipe should be installed neither more than 2mm above the mouth of tank, nor over 5mm below it, with its top end being made rounded to avoid damaging the O-ring of riser pipe.

③ Make sure not to slide off the O-ring of base when you install the valve.

④ Keep inlet and outlet pipelines parallel with one another, and fix them with support holder.

⑤ It's forbidden to use pipelines or connectors as supporting or lifting tool; Do not tighten or unscrew thread pipes with too much force, in case of damaging the valve.

⑥ PPR pipe, corrugated pipe and UPVC pipe are recommended in

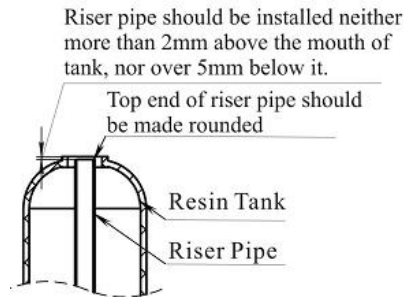

Figure 1

pipeline construction instead of polyethylene-aluminum pipe.

⑦The control valve should be mounted above the drain outlet.

⑧As in Figure 2, it's forbidden to connect the drain pipeline directly to the drain outlet. Some certain space is needed in between in case that dirty water is siphoned back to the device.

⑨Handle and hand wheel can only be rotated to right or left, within its limits, and can't be flipped up and down.

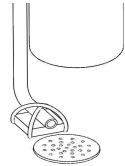

5. System Configuration and Flow Rate Features

A. System Configuration and Flow Rate Parameters

Figure 2

Tank size				Activated Carbon Filter		Sand Filter		
Diameter		Height	Tank Volume	Filter Material Volume	Filter Flow Rate	Backwash Flow Rate	Filter Flow Rate	Backwash Flow Rate
in	mm	in	L	L	m ³ /h	m ³ /h	m ³ /h	m ³ /h
6	152	35	14.4	10	0.2	0.7	0.4	1.0
7	178	44	25.4	17	0.3	0.9	0.6	1.3
8	203	44	32.9	22	0.4	1.1	0.8	1.7
9	229	48	44.7	30	0.5	1.5	1.0	2.2
10	254	54	65.3	41	0.6	1.7	1.2	2.6
12	305	65	89.2	59	0.8	2.5	1.7	3.8
13	330	54	113.8	69	1.0	3.0	2.1	4.6
14	356	65	150.3	103	1.2	3.4	2.4	5.2
16	406	65	189.6	120	1.5	4.5	3.1	6.8
18	457	65	253	169	2.0	5.9	4.1	8.8
20	508	72	310.5	207	2.4	7.0	4.9	10.6
22	550	72	385	255	2.8	8.5	5.9	12.8
24	610	88	480	320	3.4	10.0	7.0	15.2

Note: The listed activated carbon filter flow rate is outcome of calculation based on a flow velocity of 12m/h; The backwash rate is based on a backwash intensity of 10L/(m² *s). The above sand filter flow rate correspond s to a flow velocity of 25m/h; The backwash rate is related to

a backwash intensity of 15L/(m²*s)

B.Flow Rate Curve

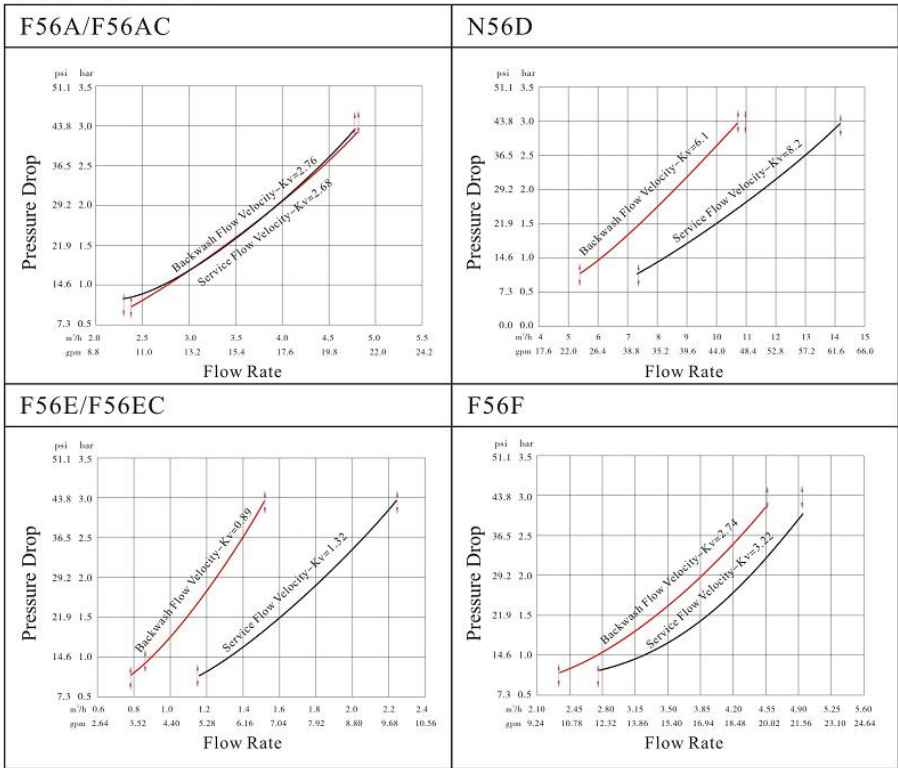

F56L

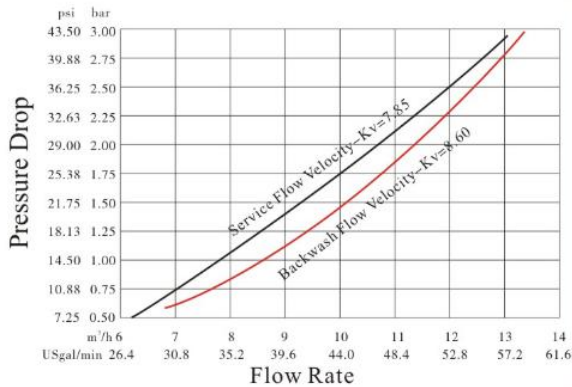

WENZHOU RUNXIN MANUFACTURING MACHINE CO., LTD.
ADD.: NO.169, RUNXIN ROAD, SHANFU TOWN, WENZHOU,
ZHEJIANG, CHINA.

TEL.: 0086-577-88630038, 88576512, 85956057

FAX: 0086-577-88633258

E-MAIL: sales@run-xin.com

<http://www.run-xin.com>